

FL+6800ラダー

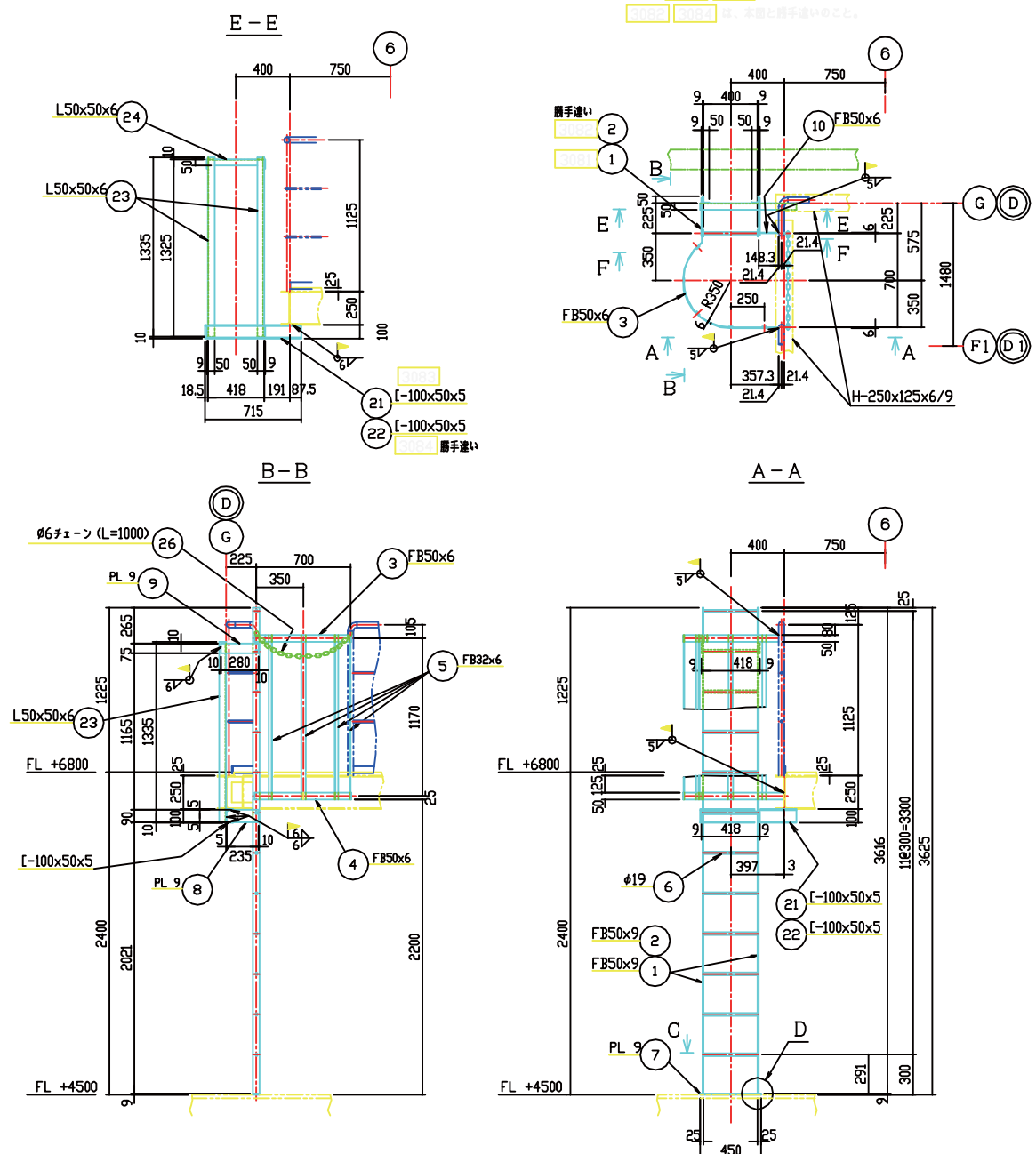

FL+4500 手摺改造配置図

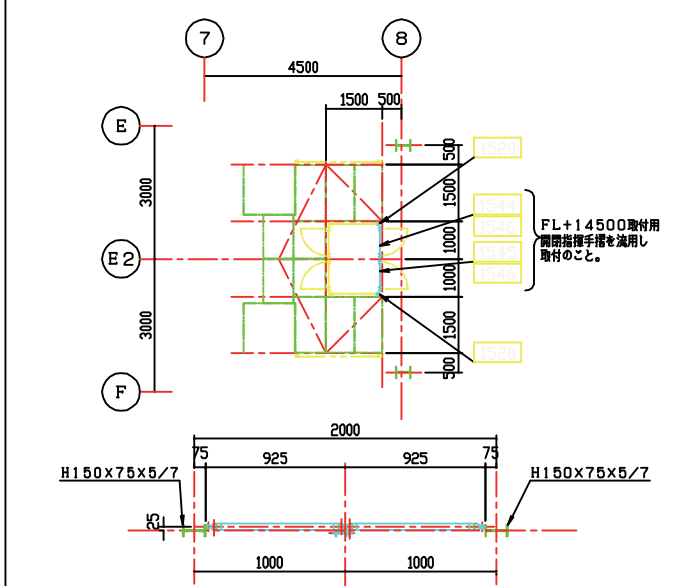

FL+14500 手摺改造配置図

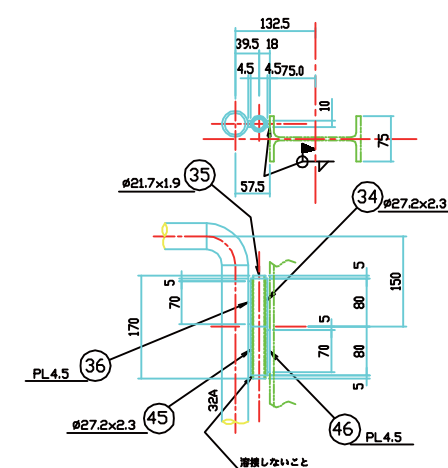
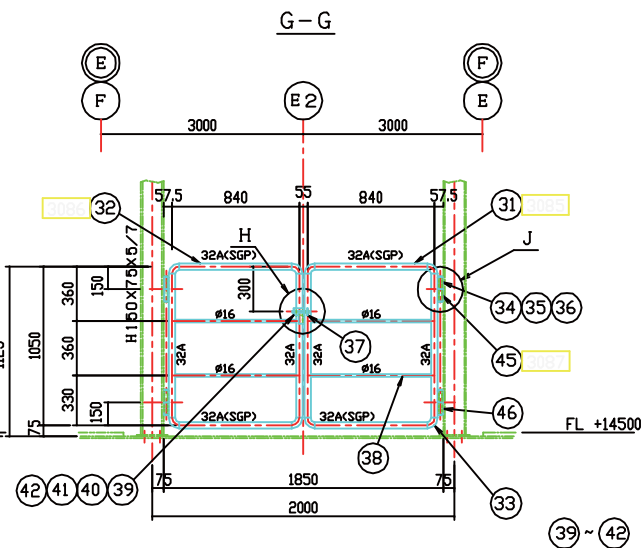
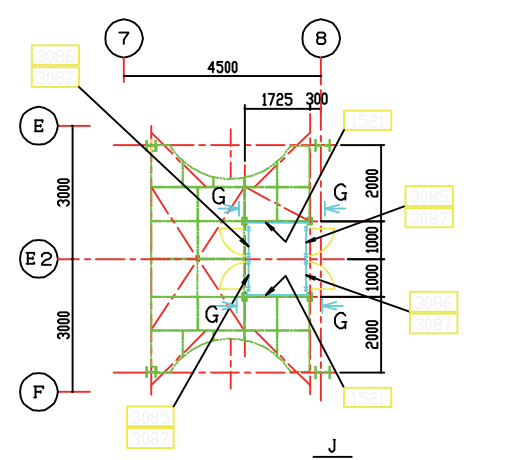

チェーン取付部詳細

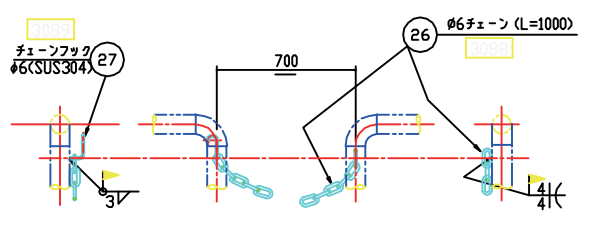

チェーンフック詳細

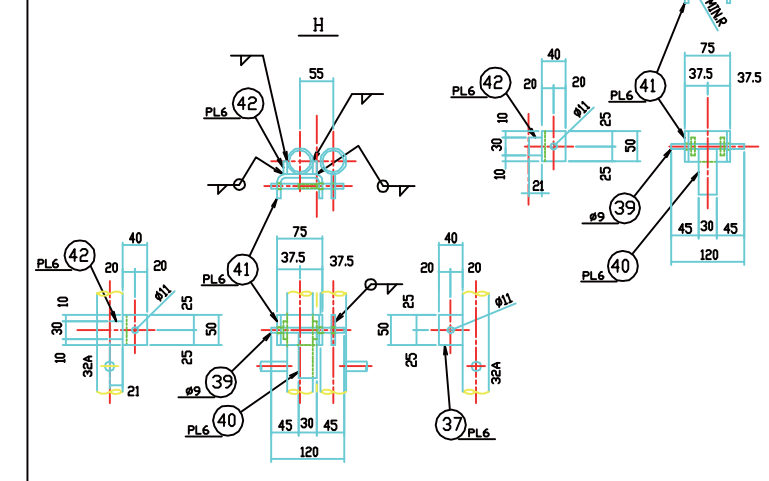
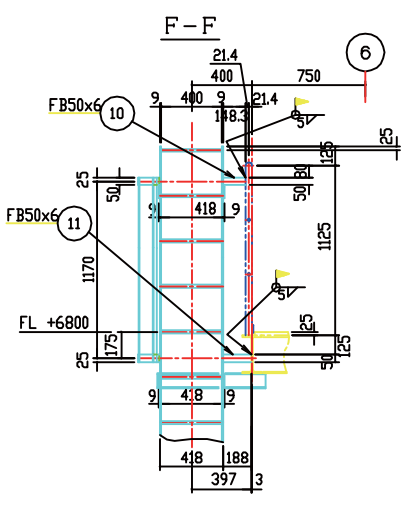
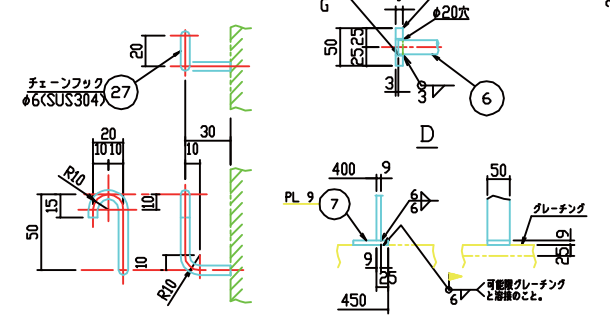

品名	数量	材料	寸法	単位	重量
31	1	SSP	32A 30P	kg	0.8
32	4	SSP	32A 30P	kg	3.2
33	1	STK400	#17.7x1.9-170	kg	0.134
34	2	STK400	#17.7x1.9-170	kg	0.268
35	2	STK400	#21.7x1.9	kg	0.268
36	1	SS400	PL4.5	kg	0.230
37	1	SS400	PL6	kg	0.179
38	1	SS400	#16-173B	kg	2.75
39	1	SS400	#6-103	kg	0.023
40	1	SS400	PL4.5	kg	0.230
41	1	SS400	PL6	kg	0.179
42	1	SS400	PL6	kg	0.179
43	1	SS400	#6-103	kg	0.023
44	1	SS400	PL4.5	kg	0.230
45	1	SS400	#21.7x1.9	kg	0.268
46	1	SS400	PL4.5	kg	0.230

品名	数量	材料	寸法	単位	重量
1	1	SSP	32A 30P	kg	0.8
2	1	SSP	32A 30P	kg	0.8
3	1	SSP	32A 30P	kg	0.8
4	1	SSP	32A 30P	kg	0.8
5	2	SSP	32A 30P	kg	1.6
6	1	STK400	#17.7x1.9-170	kg	0.134
7	1	STK400	#17.7x1.9-170	kg	0.134
8	2	STK400	#17.7x1.9-170	kg	0.268
9	2	STK400	#17.7x1.9-170	kg	0.268
10	1	SS400	PL4.5	kg	0.230
11	1	SS400	PL6	kg	0.179
12	1	SS400	#16-173B	kg	2.75
13	2	SS400	#6-103	kg	0.046
14	1	SS400	PL4.5	kg	0.230
15	1	SS400	PL6	kg	0.179
16	1	SS400	#6-103	kg	0.023
17	1	SS400	PL4.5	kg	0.230
18	1	SS400	PL6	kg	0.179
19	1	SS400	#6-103	kg	0.023
20	1	SS400	PL4.5	kg	0.230
21	1	SS400	PL6	kg	0.179
22	1	SS400	#6-103	kg	0.023
23	1	SS400	PL4.5	kg	0.230
24	1	SS400	PL6	kg	0.179
25	1	SS400	#6-103	kg	0.023
26	1	SS400	PL4.5	kg	0.230
27	2	SS400	#6-103	kg	0.046
28	1	SS400	PL4.5	kg	0.230
29	1	SS400	PL6	kg	0.179
30	1	SS400	#6-103	kg	0.023
31	1	SSP	32A 30P	kg	0.8
32	4	SSP	32A 30P	kg	3.2
33	1	STK400	#17.7x1.9-170	kg	0.134
34	2	STK400	#17.7x1.9-170	kg	0.268
35	2	STK400	#21.7x1.9	kg	0.268
36	1	SS400	PL4.5	kg	0.230
37	1	SS400	PL6	kg	0.179
38	1	SS400	#16-173B	kg	2.75
39	1	SS400	#6-103	kg	0.023
40	1	SS400	PL4.5	kg	0.230
41	1	SS400	PL6	kg	0.179
42	1	SS400	PL6	kg	0.179
43	1	SS400	#6-103	kg	0.023
44	1	SS400	PL4.5	kg	0.230
45	1	SS400	#21.7x1.9	kg	0.268
46	1	SS400	PL4.5	kg	0.230